

W. Krömker GmbH / Nordring 27a / 31675 Bückeburg

Field Safety Notice

05th August, 2022

Subject: Possible loosening of a coupling at the rear joint of the "BEWATEC.Wandarm 500 plus"

Affected products:

Spring arms "BEWATEC.Wandarm 500 plus" with serial number range 2019XXXX (X corresponds to one digit each) to 2021XXXX (X corresponds to one digit each) from year of manufacture June 2019 to November 2021

Safety issue:

Within the scope of strict quality control and continuous market monitoring, W. Krömker GmbH has become aware of a problem with the products listed above, which may cause the couplings at the rear joint to loosen during certain movements.

In the event of such loosening of the first coupler, the arm will initially begin to drift during operation. With further use and at the same time jerky movement against the height stop, the second coupler can also become loose. This can cause the system to drop suddenly, which could result in injury to the patient, clinical staff or third parties.

Measures to be taken by the customer/ operator:

1. (1) Immediately identify the affected products and inspect them according to the procedure described in Enclosure 3.
2. If one of the two couplers is not in the correct position, the product must be temporarily shut down.
3. Please complete the confirmation letter attached in Enclosure 4 and return it to: info@kroemker.com

Should you require our assistance with the check described above, please contact our technical contact Mr. Krauß at any time: +49 5722 9054 - 46

KONTAKT

Fon +49 (0) 57 22 90 54-30
+49 (0) 57 22 2 17 44
Fax +49 (0) 57 22 90 54-54
E-Mail info@kroemker.com
Web www.kroemker.com

GESCHÄFTSFÜHRER

Andreas Mühlenbeck
Jürgen Roth
Sitz der Gesellschaft: Bückeburg
Amtsgericht: Stadthagen HRB 2810
USt.-ID-Nr.: DEB11270246

KONTOVERBINDUNG

Commerzbank AG
BLZ 300 400 00
Kto. 103 6045
SWIFT-BIC COBADEFFXXX
IBAN DE63 3004 0000 0103 6045 00

Deutsche Apotheker und Ärzte Bank eG
BLZ 300 606 01
Kto. 4 4345 70
SWIFT-BIC DAAEDEDXXX
IBAN DE13 3006 0601 0004 4345 70

We are currently working on providing you with a retrofit kit for all affected wall arms, which can be used to prevent the couplers from coming loose. We will inform you about the further procedure of providing this retrofit kit or a necessary replacement of individual spring arms in a separate letter.

Further information:

The investigations carried out showed that the loosening of a coupler is due to insufficient granulation in combination with impacting movements against the height stop. This problem exclusively affects spring arms of the product "Wandarm 500 plus" produced in the period from June 2019 to November 2021.

Deliveries from production year/serial number 2022 are not affected due to technical changes of the spring arm.

The existing problem is a gradual process, in the course of which first one and later also the other coupler on the joint can become loose during shocking movements.

It is therefore important to observe the safety instructions contained in our instructions for use in connection with the use of the products. The wall arm may only be moved slowly and without hitting it hard in the end positions

The product must be serviced at regular intervals, paying particular attention to the following signs:

- The monitor bracket drifts and does not hold the monitor in a horizontal position.
- Scraping or cracking noises occur during use
- The hinge cover is bowed or cracked on the top when the spring arm is aligned all the way down.

If inspection of the spring arms reveals the above abnormalities, refrain from further use until the retrofit kit is installed or the spring arm is replaced. Affected spring arms should be temporarily decommissioned.

Please make sure that all potential users are informed about this safety notice and the corresponding recommendations for behavior and keep this document in your records. This information has been forwarded to the appropriate national authority.

We apologize for any inconvenience this action may cause you and thank you for your cooperation. We assure you that maintaining our high level of safety and quality is our highest priority.

If you have any questions in connection with this information, please do not hesitate to contact our contact persons Mr. Hanisch or Mr. Gellermann at +49 (0) 5722 9054 40.

KONTAKT

Fon +49 (0) 57 22 90 54-30
+49 (0) 57 22 2 17 44
Fax +49 (0) 57 22 90 54-54
E-Mail info@kroemker.com
Web www.kroemker.com

GESCHÄFTSFÜHRER

Andreas Mühlenbeck
Jürgen Roth
Sitz der Gesellschaft: Bückeburg
Amtsgericht: Stadthagen HRB 2810
USt.-ID-Nr.: DE811270246

KONTOVERBINDUNG

Volksbank in Schaumburg eG
BLZ 255 914 13
Kto. 31 172 300
SWIFT-CODE: GENO DE F1 BCK
DE58 2559 1413 0031 1723 00

Sparkasse Schaumburg
BLZ 255 514 80
Kto. 341 848 513
SWIFT-BIC: NOLADE21SHG
DE73 2555 1480 0341 8485 13

With best regards,

W. Krömker GmbH



Managing Director

Enclosure 1: Identification of the serial number on the spring arm

Enclosure 2: Listing of the affected serial numbers

Enclosure 3: Verification of functionality at the rear joint

Enclosure 4: Acknowledgement of receipt and confirmation of execution

KONTAKT

Fon +49 (0) 57 22 90 54-30
+49 (0) 57 22 2 17 44
Fax +49 (0) 57 22 90 54-54
E-Mail info@kroemker.com
Web www.kroemker.com

GESCHÄFTSFÜHRER

Andreas Mühlenbeck
Jürgen Roth
Sitz der Gesellschaft: Bückeberg
Amtsgericht: Stadthagen HRB 2810
USt.-ID-Nr.: DEB11270246

KONTOVERBINDUNG

Volksbank in Schaumburg eG
BLZ 255 914 13
Kto. 31 172 300
SWIFT-CODE: GENO DE F1 BCK
DE58 2559 1413 0031 1723 00

Sparkasse Schaumburg
BLZ 255 514 80
Kto. 341 848 513
SWIFT-BIC: NOLADE21SHG
DE73 2555 1480 0341 8485 13

Anlage 1: Identifikation der Seriennummer am Federarm

Enclosure 1: Identification of the serial number on the spring arm

Auffinden des Typenschildes/ Locating the type label:

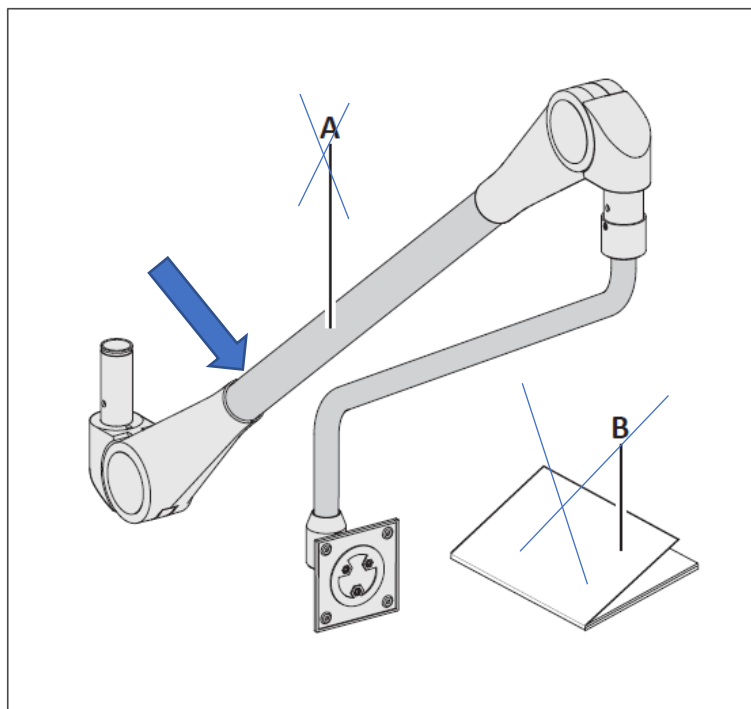



BEWATEC.Wandarm 500 plus		BEWATEC [®]	
REF 3-145-001	RI 01		(01) 4260217220042
SN 20210001	 2021-03-17		(11) 210317
Vertrieb durch: BEWATEC Kommunikationstechnik GmbH			max. load
Distributed by: Orkotten 65, 48291 Telgte, Germany			2,7 kg
	W. Krömker GmbH Nordring 27a 31675 Bückeburg, Germany		

BEWATEC.Wandarm 500 plus

REF 7520-2114-02-00-0081-900 **RI** 01



 2021-06-15 **SN** 20210000

 max. load: 2,7 kg

 W. Krömker GmbH
Nordring 27a
31675 Bückeburg, Germany

 (01) 04260217220042
(11) 210615
(21) 20210000

96000-847

MD  

BEWATEC.Wandarm 500 plus **BEWATEC**[®]

REF 3-145-002 **RI** 00

SN 20190000  2019-07-25

 (01) 4260217220066
(11) 190725
(21) 20190000

Vertrieb durch: BEWATEC Kommunikationstechnik GmbH
Distributed by: Orkotten 65, 48291 Telgte, Germany

 max. load 2,7 kg

 W. Krömker GmbH
Nordring 27a
31675 Bückeburg, Germany

 

BEWATEC.Wandarm 500 plus

REF 7520-2115-02-00-0081-900 **RI** 00



 2021-07-29 **SN** 20210000

 max. load: 2,7 kg

 W. Krömker GmbH
Nordring 27a
31675 Bückeburg, Germany

 (01) 04260217220066
(11) 210729
(21) 20210000

96000-842

MD  

Anlage 2: Auflistung der betroffenen Seriennummern

Enclosure 2: List of affected serial numbers

Betroffen von der Maßnahme sind die Produkte mit den Artikelnummern 3-145-001 und 3-145-002 bzw. 7520-2114-02-00-0081-900 und 7520-2115-02-00-0081-900 in der gleichen Bauart wie der Reklamationsfall.

Die betroffenen Seriennummern sind in Tabelle 1 aufgelistet. Zum Auffinden der Seriennummer am Federarm siehe „Anlage 1: Identifikation der Seriennummer am Federarm“.

Products affected by the action are part numbers 3-145-001 and 3-145-002 or 7520-2114-02-00-0081-900 and 7520-2115-02-00-0081-900 in the same design as the complaint case.

The affected serial numbers are listed in Table 1. To find the serial number on the spring arm, see "Enclosure 1: Identification of the serial number on the spring arm".

Tabelle 1: zu überprüfende Seriennummern

Table 1: Serial numbers to be verified

20190004	20190041	20200036	20200073	20200109	20200147
20190005	20190042	20200037	20200074	20200110	20200148
20190006	20190043	20200038	20200075	20200112	20200149
20190009	20190044	20200039	20200076	20200113	20200150
20190010	20190045	20200040	20200077	20200115	20200151
20190011	20190046	20200041	20200078	20200116	20200152
20190012	20190047	20200042	20200079	20200117	20200153
20190013	20190048	20200044	20200080	20200119	20200154
20190014	20190049	20200045	20200081	20200120	20200155
20190015	20190050	20200046	20200082	20200121	20200156
20190016	20190052	20200047	20200083	20200122	20200157
20190017	20200002	20200048	20200084	20200123	20200158
20190018	20200004	20200049	20200085	20200124	20200159
20190019	20200005	20200050	20200086	20200125	20200160
20190020	20200007	20200051	20200087	20200126	20200161
20190021	20200008	20200052	20200088	20200127	20200162
20190022	20200009	20200053	20200089	20200128	20200163
20190023	20200010	20200054	20200090	20200129	20200164
20190024	20200015	20200055	20200091	20200130	20200165
20190025	20200017	20200056	20200092	20200131	20200166
20190026	20200018	20200057	20200093	20200132	20200167
20190027	20200020	20200058	20200094	20200133	20200168
20190028	20200021	20200059	20200095	20200134	20200169
20190029	20200022	20200060	20200097	20200135	20200170
20190030	20200023	20200061	20200098	20200136	20200171
20190031	20200024	20200062	20200099	20200137	20200172
20190032	20200025	20200064	20200100	20200138	20200173
20190033	20200027	20200065	20200101	20200139	20200174

20190034	20200028	20200066	20200102	20200140	20200175
20190035	20200029	20200067	20200103	20200141	20200176
20190036	20200031	20200068	20200104	20200142	20200177
20190037	20200032	20200069	20200105	20200143	20200178
20190038	20200033	20200070	20200106	20200144	20200179
20190039	20200034	20200071	20200107	20200145	20200180
20190040	20200035	20200072	20200108	20200146	20200181
20200182	20200227	20200272	20200317	20200362	20200407
20200183	20200228	20200273	20200318	20200363	20200408
20200184	20200229	20200274	20200319	20200364	20200409
20200185	20200230	20200275	20200320	20200365	20200410
20200186	20200231	20200276	20200321	20200366	20200411
20200187	20200232	20200277	20200322	20200367	20200412
20200188	20200233	20200278	20200323	20200368	20200413
20200189	20200234	20200279	20200324	20200369	20200414
20200190	20200235	20200280	20200325	20200370	20200415
20200191	20200236	20200281	20200326	20200371	20200416
20200192	20200237	20200282	20200327	20200372	20200417
20200193	20200238	20200283	20200328	20200373	20200418
20200194	20200239	20200284	20200329	20200374	20200419
20200195	20200240	20200285	20200330	20200375	20200420
20200196	20200241	20200286	20200331	20200376	20200421
20200197	20200242	20200287	20200332	20200377	20200422
20200198	20200243	20200288	20200333	20200378	20200423
20200199	20200244	20200289	20200334	20200379	20200424
20200200	20200245	20200290	20200335	20200380	20200425
20200201	20200246	20200291	20200336	20200381	20200426
20200202	20200247	20200292	20200337	20200382	20200427
20200203	20200248	20200293	20200338	20200383	20200428
20200204	20200249	20200294	20200339	20200384	20200429
20200205	20200250	20200295	20200340	20200385	20200430
20200206	20200251	20200296	20200341	20200386	20200431
20200207	20200252	20200297	20200342	20200387	20200432
20200208	20200253	20200298	20200343	20200388	20200433
20200209	20200254	20200299	20200344	20200389	20200434
20200210	20200255	20200300	20200345	20200390	20200435
20200211	20200256	20200301	20200346	20200391	20200436
20200212	20200257	20200302	20200347	20200392	20200437
20200213	20200258	20200303	20200348	20200393	20200438
20200214	20200259	20200304	20200349	20200394	20200439
20200215	20200260	20200305	20200350	20200395	20200440
20200216	20200261	20200306	20200351	20200396	20200441
20200217	20200262	20200307	20200352	20200397	20200442
20200218	20200263	20200308	20200353	20200398	20200443
20200219	20200264	20200309	20200354	20200399	20200444
20200220	20200265	20200310	20200355	20200400	20200445
20200221	20200266	20200311	20200356	20200401	20200446
20200222	20200267	20200312	20200357	20200402	20200447
20200223	20200268	20200313	20200358	20200403	20200448
20200224	20200269	20200314	20200359	20200404	20200449
20200225	20200270	20200315	20200360	20200405	20200450

20200226	20200271	20200316	20200361	20200406	20200451
20200452	20200497	20200542	20200587	20200632	20210004
20200453	20200498	20200543	20200588	20200633	20210005
20200454	20200499	20200544	20200589	20200634	20210006
20200455	20200500	20200545	20200590	20200635	20210007
20200456	20200501	20200546	20200591	20200636	20210008
20200457	20200502	20200547	20200592	20200637	20210009
20200458	20200503	20200548	20200593	20200638	20210010
20200459	20200504	20200549	20200594	20200639	20210011
20200460	20200505	20200550	20200595	20200640	20210012
20200461	20200506	20200551	20200596	20200641	20210013
20200462	20200507	20200552	20200597	20200642	20210014
20200463	20200508	20200553	20200598	20200643	20210015
20200464	20200509	20200554	20200599	20200644	20210016
20200465	20200510	20200555	20200600	20200645	20210017
20200466	20200511	20200556	20200601	20200646	20210018
20200467	20200512	20200557	20200602	20200647	20210019
20200468	20200513	20200558	20200603	20200648	20210020
20200469	20200514	20200559	20200604	20200649	20210021
20200470	20200515	20200560	20200605	20200650	20210022
20200471	20200516	20200561	20200606	20200651	20210023
20200472	20200517	20200562	20200607	20200652	20210024
20200473	20200518	20200563	20200608	20200653	20210025
20200474	20200519	20200564	20200609	20200654	20210026
20200475	20200520	20200565	20200610	20200655	20210027
20200476	20200521	20200566	20200611	20200656	20210028
20200477	20200522	20200567	20200612	20200657	20210029
20200478	20200523	20200568	20200613	20200658	20210030
20200479	20200524	20200569	20200614	20200659	20210031
20200480	20200525	20200570	20200615	20200660	20210032
20200481	20200526	20200571	20200616	20200661	20210033
20200482	20200527	20200572	20200617	20200662	20210034
20200483	20200528	20200573	20200618	20200663	20210035
20200484	20200529	20200574	20200619	20200664	20210036
20200485	20200530	20200575	20200620	20200665	20210037
20200486	20200531	20200576	20200621	20200666	20210038
20200487	20200532	20200577	20200622	20200667	20210039
20200488	20200533	20200578	20200623	20200668	20210040
20200489	20200534	20200579	20200624	20200669	20210041
20200490	20200535	20200580	20200625	20200670	20210042
20200491	20200536	20200581	20200626	20200671	20210043
20200492	20200537	20200582	20200627	20200672	20210044
20200493	20200538	20200583	20200628	20200673	20210045
20200494	20200539	20200584	20200629	20210001	20210046
20200495	20200540	20200585	20200630	20210002	20210047
20200496	20200541	20200586	20200631	20210003	20210048
20210049	20210094	20210139	20210184	20210229	20210274
20210050	20210095	20210140	20210185	20210230	20210275
20210051	20210096	20210141	20210186	20210231	20210276
20210052	20210097	20210142	20210187	20210232	20210277
20210053	20210098	20210143	20210188	20210233	20210278

20210054	20210099	20210144	20210189	20210234	20210279
20210055	20210100	20210145	20210190	20210235	20210280
20210056	20210101	20210146	20210191	20210236	20210281
20210057	20210102	20210147	20210192	20210237	20210282
20210058	20210103	20210148	20210193	20210238	20210283
20210059	20210104	20210149	20210194	20210239	20210284
20210060	20210105	20210150	20210195	20210240	20210285
20210061	20210106	20210151	20210196	20210241	20210286
20210062	20210107	20210152	20210197	20210242	20210287
20210063	20210108	20210153	20210198	20210243	20210288
20210064	20210109	20210154	20210199	20210244	20210289
20210065	20210110	20210155	20210200	20210245	20210290
20210066	20210111	20210156	20210201	20210246	20210291
20210067	20210112	20210157	20210202	20210247	20210292
20210068	20210113	20210158	20210203	20210248	20210293
20210069	20210114	20210159	20210204	20210249	20210294
20210070	20210115	20210160	20210205	20210250	20210295
20210071	20210116	20210161	20210206	20210251	20210296
20210072	20210117	20210162	20210207	20210252	20210297
20210073	20210118	20210163	20210208	20210253	20210298
20210074	20210119	20210164	20210209	20210254	20210299
20210075	20210120	20210165	20210210	20210255	20210300
20210076	20210121	20210166	20210211	20210256	20210301
20210077	20210122	20210167	20210212	20210257	20210302
20210078	20210123	20210168	20210213	20210258	20210303
20210079	20210124	20210169	20210214	20210259	20210304
20210080	20210125	20210170	20210215	20210260	20210305
20210081	20210126	20210171	20210216	20210261	20210306
20210082	20210127	20210172	20210217	20210262	20210307
20210083	20210128	20210173	20210218	20210263	20210308
20210084	20210129	20210174	20210219	20210264	20210309
20210085	20210130	20210175	20210220	20210265	20210310
20210086	20210131	20210176	20210221	20210266	20210311
20210087	20210132	20210177	20210222	20210267	20210312
20210088	20210133	20210178	20210223	20210268	20210313
20210089	20210134	20210179	20210224	20210269	20210314
20210090	20210135	20210180	20210225	20210270	20210315
20210091	20210136	20210181	20210226	20210271	20210316
20210092	20210137	20210182	20210227	20210272	20210317
20210093	20210138	20210183	20210228	20210273	20210318
20210319	20210364	20210409	20210454	20210499	20210544
20210320	20210365	20210410	20210455	20210500	20210545
20210321	20210366	20210411	20210456	20210501	20210546
20210322	20210367	20210412	20210457	20210502	20210547
20210323	20210368	20210413	20210458	20210503	20210548
20210324	20210369	20210414	20210459	20210504	20210549
20210325	20210370	20210415	20210460	20210505	20210550
20210326	20210371	20210416	20210461	20210506	20210551
20210327	20210372	20210417	20210462	20210507	20210552
20210328	20210373	20210418	20210463	20210508	20210553
20210329	20210374	20210419	20210464	20210509	20210554

20210330	20210375	20210420	20210465	20210510	20210555
20210331	20210376	20210421	20210466	20210511	20210556
20210332	20210377	20210422	20210467	20210512	20210557
20210333	20210378	20210423	20210468	20210513	20210558
20210334	20210379	20210424	20210469	20210514	20210559
20210335	20210380	20210425	20210470	20210515	20210560
20210336	20210381	20210426	20210471	20210516	20210561
20210337	20210382	20210427	20210472	20210517	20210562
20210338	20210383	20210428	20210473	20210518	20210563
20210339	20210384	20210429	20210474	20210519	20210564
20210340	20210385	20210430	20210475	20210520	20210565
20210341	20210386	20210431	20210476	20210521	20210566
20210342	20210387	20210432	20210477	20210522	20210567
20210343	20210388	20210433	20210478	20210523	20210568
20210344	20210389	20210434	20210479	20210524	20210569
20210345	20210390	20210435	20210480	20210525	20210570
20210346	20210391	20210436	20210481	20210526	20210571
20210347	20210392	20210437	20210482	20210527	20210572
20210348	20210393	20210438	20210483	20210528	20210573
20210349	20210394	20210439	20210484	20210529	20210574
20210350	20210395	20210440	20210485	20210530	20210575
20210351	20210396	20210441	20210486	20210531	20210576
20210352	20210397	20210442	20210487	20210532	20210577
20210353	20210398	20210443	20210488	20210533	20210578
20210354	20210399	20210444	20210489	20210534	20210579
20210355	20210400	20210445	20210490	20210535	20210580
20210356	20210401	20210446	20210491	20210536	20210581
20210357	20210402	20210447	20210492	20210537	20210582
20210358	20210403	20210448	20210493	20210538	20210583
20210359	20210404	20210449	20210494	20210539	20210584
20210360	20210405	20210450	20210495	20210540	20210585
20210361	20210406	20210451	20210496	20210541	20210586
20210362	20210407	20210452	20210497	20210542	20210587
20210363	20210408	20210453	20210498	20210543	20210588
20210589	20210634	20210679	20210725	20210770	20210815
20210590	20210635	20210680	20210726	20210771	20210816
20210591	20210636	20210681	20210727	20210772	20210817
20210592	20210637	20210682	20210728	20210773	20210818
20210593	20210638	20210683	20210729	20210774	20210819
20210594	20210639	20210684	20210730	20210775	20210820
20210595	20210640	20210685	20210731	20210776	20210821
20210596	20210641	20210686	20210732	20210777	20210822
20210597	20210642	20210687	20210733	20210778	20210823
20210598	20210643	20210688	20210734	20210779	20210824
20210599	20210644	20210689	20210735	20210780	20210825
20210600	20210645	20210690	20210736	20210781	20210826
20210601	20210646	20210691	20210737	20210782	20210827
20210602	20210647	20210692	20210738	20210783	20210828
20210603	20210648	20210693	20210739	20210784	20210829
20210604	20210649	20210694	20210740	20210785	20210830
20210605	20210650	20210695	20210741	20210786	20210831

20210606	20210651	20210696	20210742	20210787	20210832
20210607	20210652	20210697	20210743	20210788	20210833
20210608	20210653	20210698	20210744	20210789	20210834
20210609	20210654	20210699	20210745	20210790	20210835
20210610	20210655	20210700	20210746	20210791	20210836
20210611	20210656	20210701	20210747	20210792	20210837
20210612	20210657	20210702	20210748	20210793	20210838
20210613	20210658	20210703	20210749	20210794	20210839
20210614	20210659	20210704	20210750	20210795	20210840
20210615	20210660	20210705	20210751	20210796	20210841
20210616	20210661	20210706	20210752	20210797	20210842
20210617	20210662	20210707	20210753	20210798	20210843
20210618	20210663	20210708	20210754	20210799	20210844
20210619	20210664	20210709	20210755	20210800	20210845
20210620	20210665	20210710	20210756	20210801	20210846
20210621	20210666	20210711	20210757	20210802	20210847
20210622	20210667	20210712	20210758	20210803	20210848
20210623	20210668	20210713	20210759	20210804	20210849
20210624	20210669	20210714	20210760	20210805	20210850
20210625	20210670	20210715	20210761	20210806	20210851
20210626	20210671	20210716	20210762	20210807	20210852
20210627	20210672	20210717	20210763	20210808	20210853
20210628	20210673	20210718	20210764	20210809	20210854
20210629	20210674	20210719	20210765	20210810	20210855
20210630	20210675	20210720	20210766	20210811	20210856
20210631	20210676	20210722	20210767	20210812	20210857
20210632	20210677	20210723	20210768	20210813	20210858
20210633	20210678	20210724	20210769	20210814	20210859
20210860	20210882	20210904	20210926	20210948	20211005
20210861	20210883	20210905	20210927	20210949	20211026
20210862	20210884	20210906	20210928	20210950	20211027
20210863	20210885	20210907	20210929	20210951	20211028
20210864	20210886	20210908	20210930	20210952	20211029
20210865	20210887	20210909	20210931	20210953	20211030
20210866	20210888	20210910	20210932	20210954	20211031
20210867	20210889	20210911	20210933	20210955	20211032
20210868	20210890	20210912	20210934	20210956	20211033
20210869	20210891	20210913	20210935	20210957	20211034
20210870	20210892	20210914	20210936	20210958	20211035
20210871	20210893	20210915	20210937	20210959	20211036
20210872	20210894	20210916	20210938	20210960	20211037
20210873	20210895	20210917	20210939	20210961	20211038
20210874	20210896	20210918	20210940	20210962	20211039
20210875	20210897	20210919	20210941	20210963	20211040
20210876	20210898	20210920	20210942	20210964	20211041
20210877	20210899	20210921	20210943	20210965	20211042
20210878	20210900	20210922	20210944	20211001	20211043
20210879	20210901	20210923	20210945	20211002	20211044
20210880	20210902	20210924	20210946	20211003	20211132
20210881	20210903	20210925	20210947	20211004	20211133

BEWATEC.Wandarm 500 plus **BEWATEC.WallArm 500 plus**



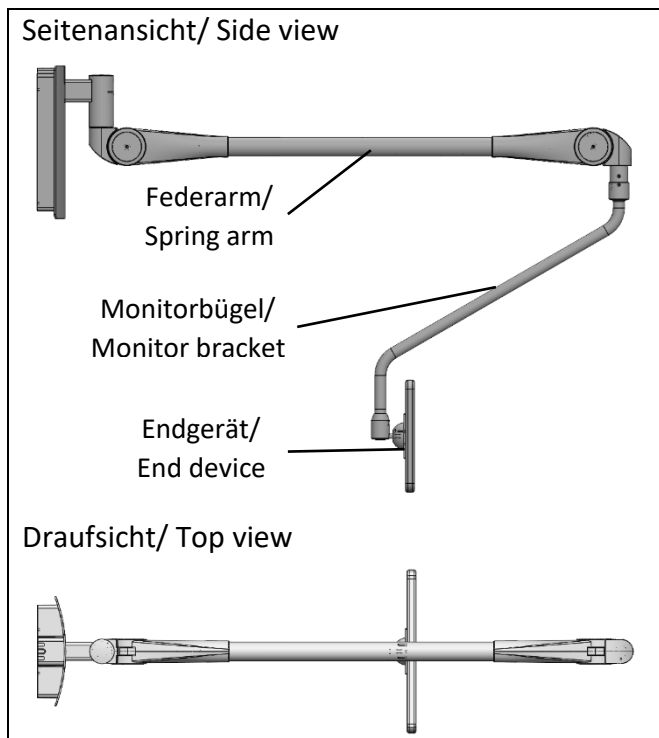

Anlage 3: Überprüfung der Funktionstüchtigkeit am hinteren Gelenk
Enclosure 3: Checking the functionality at the rear joint

3.1 Überprüfung des Monitorbügels auf Positionstreue/ Checking the monitor bracket for position accuracy



☞ Den Federarm horizontal ausrichten
Align the spring arm horizontally

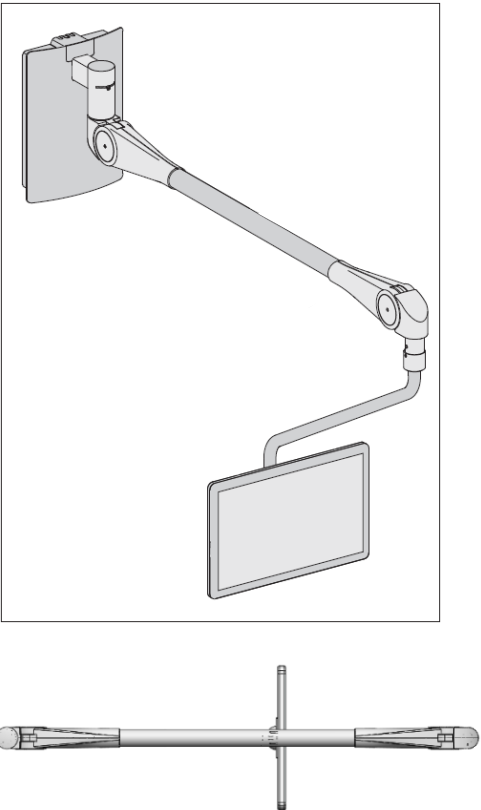
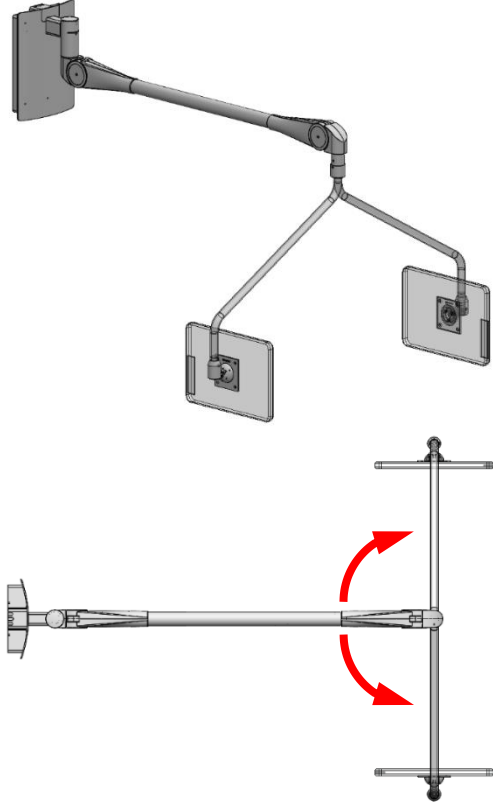



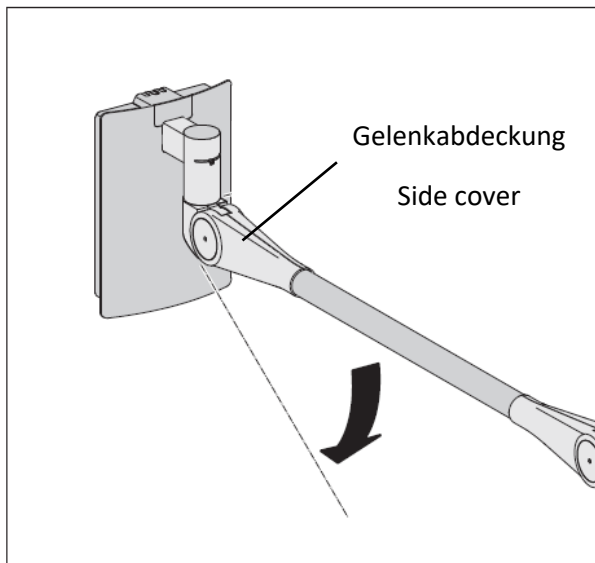

☞ Den Monitorbügel parallel zum Federarm ausrichten. Dabei das Endgerät (Tablet) zur Wand schwenken
Align the monitor bracket parallel to the spring arm. At the same time, swivel the end device (tablet) towards the wall.

	
<p>Der Monitorbügel hält die Position.</p> <p>The monitor bracket holds its position</p>	<p>Der Monitorbügel driftet selbstständig und das Endgerät (Tablet) wird nicht in Position gehalten.</p> <p>The monitor bracket drifts by itself and the end device (tablet) is not held in position.</p>
<p>Das Gerät kann weiterhin benutzt werden.</p> <p>The device can still be used.</p> 	<p>Dieses Verhalten kann auf ein defektes hinteres Gelenk hinweisen.</p> <p>This behavior may indicate a defective posterior joint.</p> 
<p>☞ Weiter mit dem nachfolgenden Schritt.</p> <p>☞ Continue with the following step</p>	<p>☞ Defektes Gerät stilllegen und deutlich als defekt kennzeichnen.</p> <p>☞ Decommission the defective device and clearly mark it as defective.</p>

3.2 Überprüfung der Gelenkabdeckungen auf Rissbildung/ Checking the joint covers for cracking



- ☞ Den Federarm ganz nach unten neigen
- ☞ Tilt the spring arm all the way down

	
	
<p>Die Gelenkabdeckung ist auf der Oberseite nicht gerissen.</p> <p>The joint cover is not cracked on the upper side</p>	<p>Die Gelenkabdeckung ist auf der Oberseite gerissen.</p> <p>The joint cover is cracked on the upper side</p>
<p>Das Gerät kann weiterhin benutzt werden.</p> <p>The device can still be used</p> <div style="text-align: center;">  </div>	<p>Dieser Riss weist auf ein defektes hinteres Gelenk hin.</p> <p>This crack indicates a defective posterior joint</p> <div style="text-align: center;">  </div>
<p>☞ Weiter mit dem nachfolgenden Schritt.</p> <p>☞ Continue with the following step.</p>	<p>☞ Defektes Gerät stilllegen und deutlich als defekt kennzeichnen.</p> <p>☞ Decommission the defective device and clearly mark it as defective.</p>

3.3 Überprüfung der Gelenkmechanik/ Checking the joint mechanics





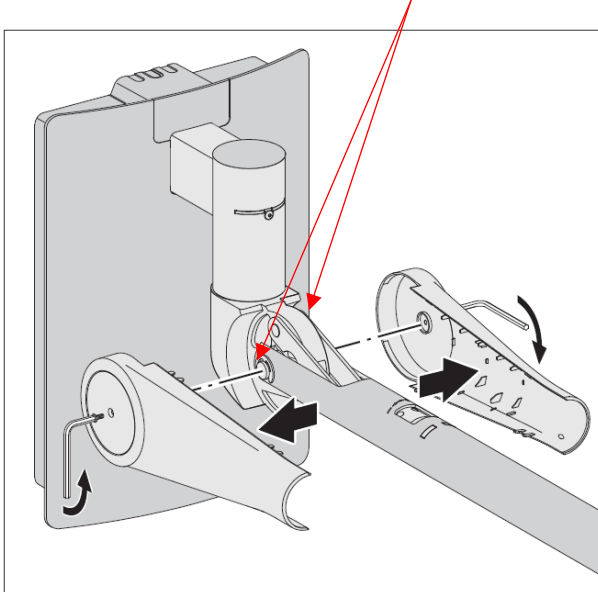

Den Sitz der Koppeln auf der Achse auf **beiden Seiten** des Gelenkes prüfen.

Check the fit of the couplers on the axle on both sides of the joint

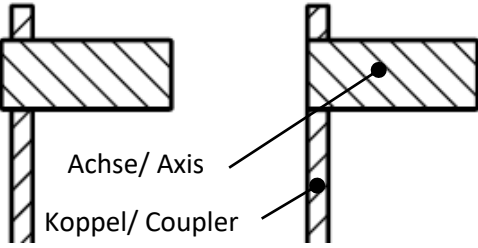
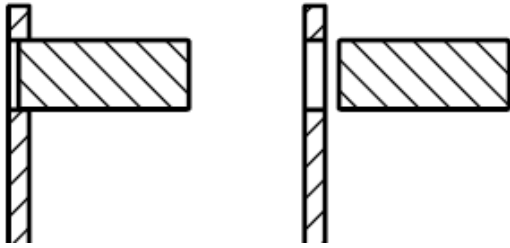
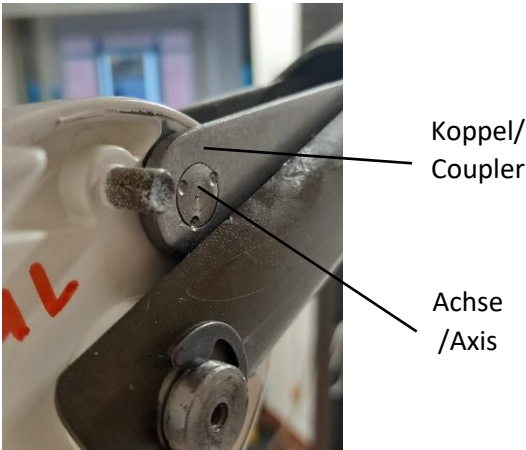

☞ Die Gelenkabdeckung abschrauben (Werkzeug: Innensechskantschlüssel SW2)

☞ Unscrew the joint cover (tool: SW2 allen key).

	
	
	
<p>Koppel steht zurück / Koppel ist bündig mit der Achse Coupler stands back / Coupler is flush with the axis</p>	<p>Koppel steht über die Achse hervor / Koppel ist abgesprungen Coupler protrudes over the axle / Coupler has jumped off</p>
<p>Das Gerät kann weiterhin benutzt werden. The device can still be used.</p> 	<p>Die Mechanik ist defekt. The mechanics is defective</p> 
<p>☞ Gelenkabdeckungen wieder montieren (handfest anziehen - Anzugsmoment ~0,3 Nm). ☞ Refit the joint covers (hand-tighten - tightening torque 0.3 Nm).</p>	<p>☞ Defektes Gerät stilllegen und deutlich als defekt kennzeichnen. ☞ Shut down defective device and clearly mark it as defective</p>

Anlage 4: Empfangsbestätigung und Durchführungsbestätigung

Bestätigung des Kunden

Dringender Sicherheitshinweis

Betreff: Mögliches Lösen einer Koppel am Gelenk hinten des „BEWATEC.Wandarm 500 plus“

Durch meine Unterschrift bestätige ich, dass

ich die folgenden Dokumente erhalten, gelesen und verstanden habe:

Sicherheitshinweis zu Wandarm 500 plus – Mögliches Lösen einer Koppel am Gelenk hinten

der Sicherheitshinweis mit allen Anlagen an alle Endanwender weitergeleitet wurde.

jedes Produkt, dass in der Überprüfung gemäß Anlage 3 nicht in Ordnung war, stillgelegt wurde.

Unternehmen: _____

Land: _____

Name: _____

Datum: _____

Unterschrift: _____

Unterzeichnen Sie dieses Informationsschreiben und senden Sie es per E-Mail an
W. Krömker:

info@kroemker.com

Betreff: Sicherheitshinweis Wandarm 500 plus - K2021101

Auf der nachfolgenden Seite finden Sie einen Vordruck zur Auflistung der Seriennummern (SN) und zur Notierung des Ergebnisses der Überprüfung in den Krankenhäusern.

✓: Wandarm ist in Ordnung ✍️: Mitarbeiter, der die Überprüfung durchgeführt hat

✗: Wandarm ist nicht in Ordnung 📅: Datum der Überprüfung

Senden Sie die Ergebnisse der Überprüfung ebenfalls per E-Mail an W. Krömker.

Enclosure 4: Acknowledgement of receipt and confirmation of execution

Confirmation of the customer

Urgent safety notice

Subject: Possible loosening of a coupling at the rear joint of the "BEWATEC wall arm 500 plus

By signing this document, I confirm that

I have received, read and understood the following documents:

Safety instructions for wall arm 500 plus - Possible loosening of a coupler at the rear joint.

the safety note with all enclosures have been forwarded to all end users.

any product that was found to be out of order in the inspection according to Enclosure 3 has been decommissioned.

Company: _____

Land: _____

Name: _____

Date: _____

Signature: _____

Sign and email this information letter to W. Krömker:

info@kroemker.com

Subject: Safety note wall arm 500 plus - K2021101

On the following page you will find a form for listing the serial numbers (SN) and noting the result of the inspection in the hospitals.

✓ : Wall arm is OK  : Staff member who performed the check.

✗ : Wall arm is not in order  : Date of the check.

Send the results of the review also by e-mail to W. Krömker.

SN	✓	✗		
XXXXXXXX				